



SDS1000X-E Series
SDS1000X-U Series
Super Phosphor
Oscilloscope

Quick Start

July, 2020



Copyright Information

SIGLENT TECHNOLOGIES CO., LTD. All Rights Reserved.

Declaration

SIGLENT products are protected by patent law in and outside of P.R.C.

SIGLENT reserves the right to modify or change parts of or all the specifications or pricing policies at company's sole decision.

Information in this publication replaces all previously corresponding material.

Any way of copying, extracting or translating the contents of this manual is not allowed without the permission of **SIGLENT**.

Note: SIGLENT is the registered trademark of SIGLENT TECHNOLOGIES CO., LTD.

SIGLENT TECHNOLOGIES CO., LTD.

Address: Blog No.4 & No.5, Antongda Industrial Zone, 3rd Liuxian Road, Bao'an District, Shenzhen, 518101, China.

Tel: +86-755-36615186

E-mail: sales@siglent.com

Http://www.siglent.com

General Safety Summary

Carefully read the following safety precautions to avoid any personal injury or damage to the instrument and any products connected to it. To avoid potential hazards, please use the instrument as specified.

Use Proper Power Cord

Only the power cord designed for the instrument and authorized by local country could be used.

Ground the Instrument

The instrument is grounded through the protective earth conductor of the power cord. To avoid electric shock, please make sure the instrument is grounded correctly before connecting its input or output terminals.

Connect the Signal Wire Correctly

The potential of the signal wire ground is equal to the earth, so do not connect the signal wire to a high voltage.

Look Over All Terminals' Ratings

To avoid fire or electric shock, please look over all ratings and sign instruction of the instrument. Before connecting the instrument, please read the manual carefully to gain more information about the ratings.

Use Proper Overvoltage Protection

Make sure that no overvoltage (such as that caused by a thunderstorm) can reach the product, or else the operator might expose to danger of electrical shock.

Electrostatic Prevention

Operate in an electrostatic discharge protective area environment to avoid damages induced by static discharge. Always ground both the internal and external conductors of the cable to release static before connecting.

Keep Well Ventilation

Inadequate ventilation may cause increasing of temperature, which may eventually damage the instrument. So keep well ventilation and inspect the intake and fan regularly.

Avoid Circuit or Components Exposed

Do not touch exposed contacts or components when the power is on.

Use Only the Specified Fuse

Do Not Operate Without Covers

Do not operate the instrument with covers or panels removed.

Safety Terms and Symbols

Terms on the product. These terms may appear on the product:

- DANGER** Indicates direct injuries or hazards that may happen.
WARNING Indicates potential injuries or hazards that may happen.
CAUTION Indicates potential damages to the instrument or other property that may happen.

Symbols on the product. These symbols may appear on the product:



General Care and Cleaning

Care

Do not store or leave the instrument in direct sunshine for long periods of time.

Notice:

To avoid damages to the instrument or probe, please do not leave them in fog, liquid, or solvent.

Cleaning

Please perform the following steps to clean the instrument and probe regularly according to its operating conditions.

1. Disconnect the instrument from all power sources, and then clean it with a soft wet cloth.
2. Clean the loose dust on the outside of the instrument and probe with a soft cloth. When cleaning the LCD, take care to avoid scratching it.

Notice:

To avoid damages to the surface of the instrument and probe, please do not use any corrosive liquid or chemical cleanser.

Make sure that the instrument is completely dry before restarting it to avoid short circuits or personal injuries.

Contents

| | |
|-----------------------------|----|
| Copyright Information..... | I |
| General Safety Summary..... | II |
| Quick start..... | 2 |
| The Front Panel | 6 |
| The Rear Panel..... | 9 |
| Front Panel Overview..... | 12 |
| User Interface..... | 20 |
| Using Security Lock..... | 22 |
| Troubleshooting..... | 23 |
| Contact SIGLENT..... | 25 |

Quick Start

General Inspection

1. Inspect the shipping container

Keep the damaged shipping container or cushioning material until the contents of the shipment have been completely checked and the instrument has passed both electrical and mechanical tests.

The consigner or carrier will be responsible for damages to the instrument resulting from shipment. SIGLENT would not provide free maintenance or replacement if the instrument has been damaged in shipment.

2. Inspect the instrument

If there are instruments found damaged, defective or failure in electrical and mechanical tests, please contact SIGLENT.

3. Check the accessories

Please check the accessories according to the packing list. If the accessories are incomplete or damaged, please contact your SIGLENT sales representative.

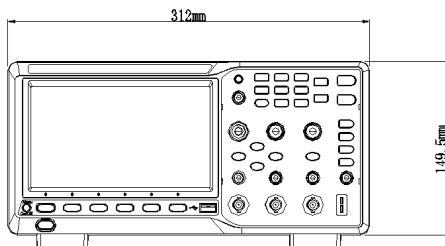

2-Channel Scope Front View

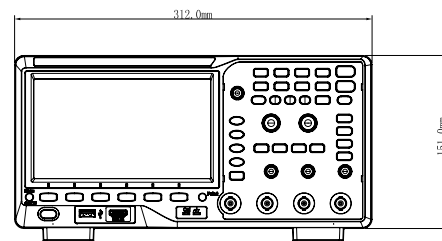

4-Channel Scope Front View

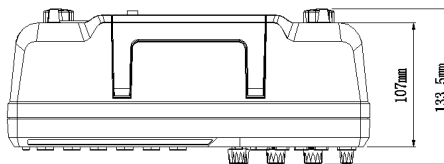

2-Channel Scope Top View

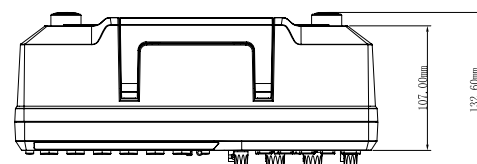

4-Channel Scope Top View

Quick Start

Adjust the Supporting Legs

Adjust the supporting legs properly to use them as stands to tilt the oscilloscope upwards for stable placement as well as easier operation and observation of the instrument.

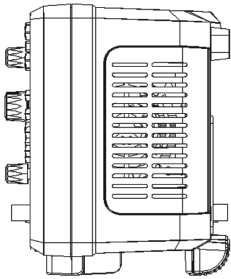

▲ Before adjusting

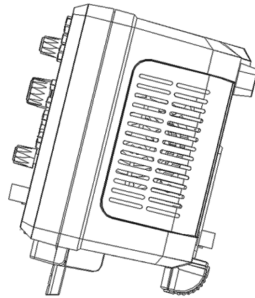

▲ After adjusting

Connect to AC Power Supply

The oscilloscope accept 100-240V, 50/60/440Hz AC power supply. Please use the power cord provided as accessories to connect the instrument to the power source as shown in the figure below.

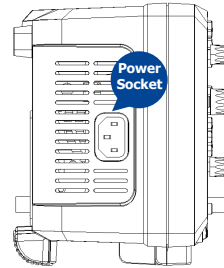

▲ To Connect to Power Supply(2-Channel Scope)

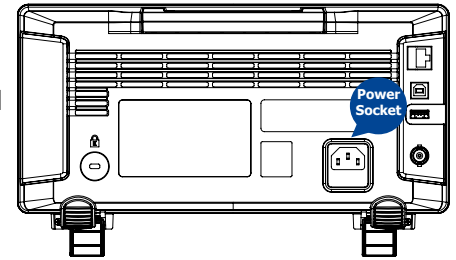

▲ To Connect to Power Supply(4-Channel Scope)

Note: If at any time the fuse requires replacement, please replace only with a fuse of the same rating as the original. If there are questions, please contact Siglent directly.

Quick Start

Power-on Inspection

When the scope is energized, turn on the power switch at the lower left corner on the front panel. During the start-up process, the instrument performs a series of self-test items and you can hear the sound of relay switching. After the self-test completed, the User Interface displays immediately.

Connect the Probe

SIGLENT provides passive probe for the SDS1000X-E and SDS1000X-U series oscilloscope. Please refer to corresponding Probe User Manual for detailed technical information.

Connect the probe:

1. Connect the BNC terminal of the probe to one of the channel BNC connector of the front panel.
2. Connect the probe tip to the circuit point to test and the ground alligator clip of the probe to the ground terminal of the circuit.

Functional Inspection

1. Press **Default** to reset the oscilloscope to its factory default setup.
2. Connect the ground alligator clip of the probe to the Ground Terminal on the front panel.
3. Use the probe to connect the CH1 Input Terminal and the Compensation Signal Output Terminal on the front panel.
4. Press **Auto Setup**
5. Observe the waveform on the screen. In normal condition, the display should be a square waveform as shown in the photo to the right.
6. Test the other channels in the same method. If the actual square waveforms does not match that in the photo shown, please perform "Probe Compensation".

Note: To avoid electric shock when using the probe, first please make certain that the insulated wire of the probe is in good condition, and do not touch the metallic part of the probe when it is connected to a high voltage.

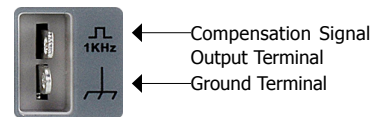

▲ 2-channel scope

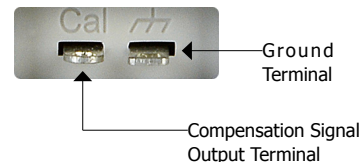

▲ 4-channel scope

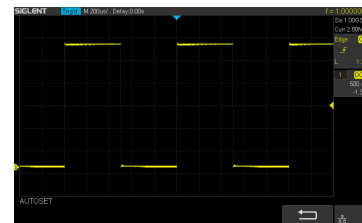

Quick Start

Probe Compensation

You should properly compensate the probe at first use of it. Non-compensated or inadequate compensated probe may cause inaccurate measurement. The following steps are about probe compensation:

1. Perform step 1, 2, 3 and 4 of "Functional Inspection".
2. Check the displayed waveforms and compare them with the following figure.

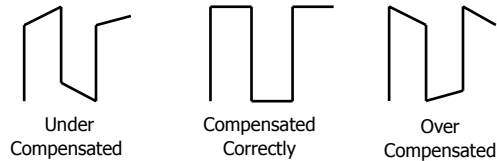

3. Use a nonmetallic driver to adjust the low-frequency compensation adjustment hole on the probe until the waveform changes to be correct as the figure above.

SDS1004X-E Front Panel

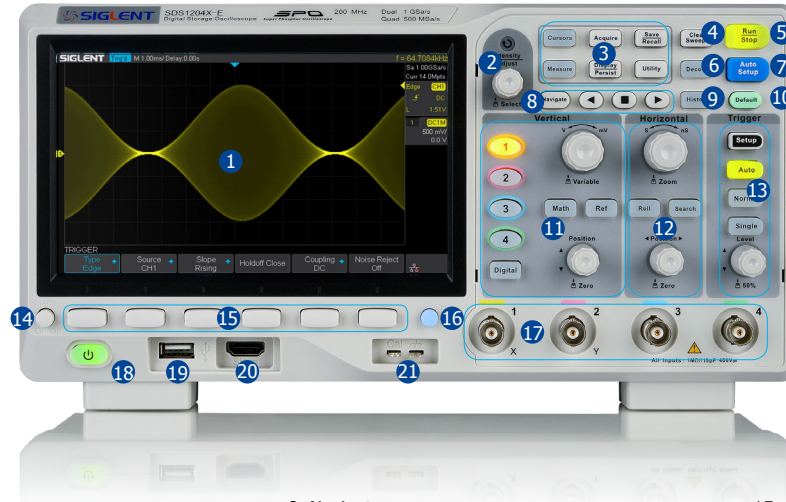

- | | | |
|--------------------------|---|---|
| 1. LCD Display | 8. Navigate | 15. Menu Softkey |
| 2. Universal Knob | 9. History | 16. One-Button shortcut for Save |
| 3. Common Function Menus | 10. Default | 17. Analog Channel |
| 4. Clear Sweeps | 11. Vertical Control, Math, REF and Digital | 18. Power Button |
| 5. Run/Stop | 12. Horizontal Control | 19. USB Host |
| 6. Decode | 13. Trigger Control | 20. SBUS Digital Inputs ^① |
| 7. Auto Setup | 14. Menu on/off | 21. Probe Compensation/ Ground Terminal |

① WARNING: Non-standard HDMI interface, Siglent device ONLY, or you will damage your devices.

SDS1002X-E Front Panel

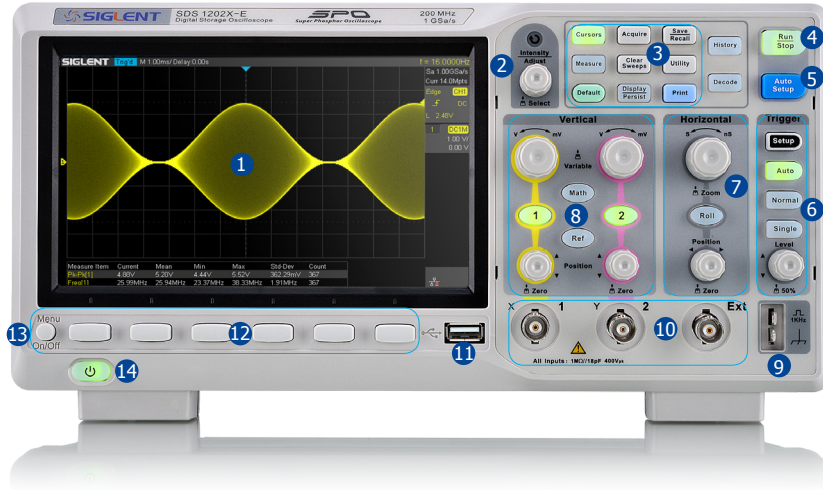

1. User Interface
2. Universal Knob
3. Function Menus
4. Run/Stop
5. Auto Setup

6. Trigger Control
7. Horizontal Control
8. Channel Vertical Control
10. Analog Channel Inputs

9. Probe Compensation
11. USB Host
12. Function Menu Softkeys
13. Menu On/Off
14. Power On/Off

SDS100X-U Front Panel

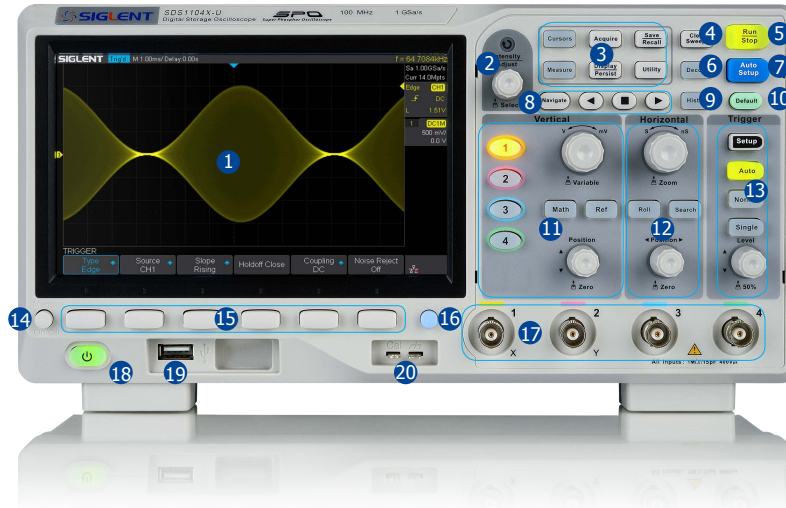

1. LCD Display
2. Universal Knob
3. Common Function Menus
4. Clear Sweeps
5. Run/Stop
6. Decode
7. Auto Setup

8. Navigate
9. History
10. Default
11. Vertical Control, Math and REF
12. Horizontal Control
13. Trigger Control
14. Menu on/off

15. Menu Softkey
16. One-Button shortcut for Save
17. Analog Channel
18. Power Button
19. USB Host
20. Probe Compensation/ Ground Terminal

SDS1004X-E Rear Panel

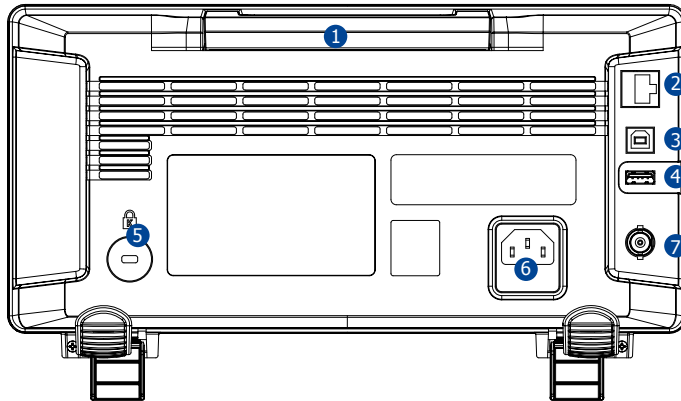

1.Handle

Pull up the handle vertically for easy carrying of the instrument. When you do not need the handle, press it down.

2.LAN Interface

The instrument can be connected to network via this interface to perform remote control.

3.USB Device

The oscilloscope support SCPI remote control commands, user can control the oscilloscope through this interface

4.USB Host

5.Safety Lock Hole

You can lock the instrument to a fixed location using the security lock (please buy it yourself) via the lock hole.

6.AC Power Socket

AC power input terminal. The power requirements of this oscilloscope are 100-240 V, 50/60/400 Hz. Use the power cord provided with the instrument to connect it to AC power.

7.Pass/Fail or Trigger Out

The BNC port can output a signal that reflects the current waveform capture rate of the oscilloscope at each trigger or a pass/fail test pulse.

SDS1002X-E Rear Panel

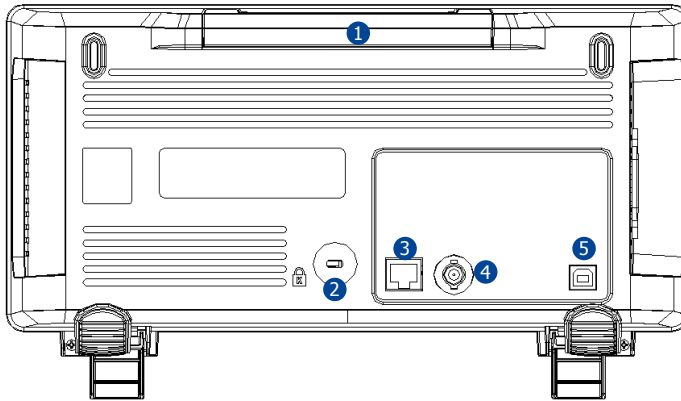

1. Handle

Pull up the handle vertically for easy carrying; press it down if you do not need the handle.

2. Safety Lock Hole

You could lock the instrument in a fixed location using a security lock (please buy it yourself) via the lock hole

3. LAN Interface

The instrument can be connected to network via this interface to perform remote control

4. Pass/Fail or Trig Out Output

Via this interface the oscilloscope can output a signal that can reflect the current capture rate of the instrument at each trigger or a Pass/Fail pulse.

5.USB Device

The oscilloscope support SCPI remote control commands, User can control the oscilloscope through this interface

SDS1000X-U Rear Panel

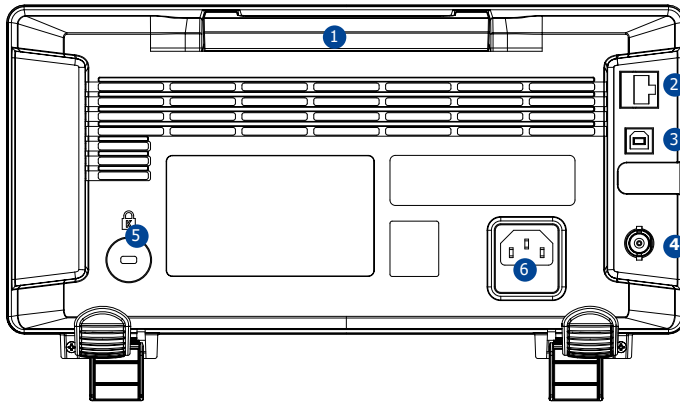

1. Handle

Pull up the handle vertically for easy carrying of the instrument. When you do not need the handle, press it down.

2. LAN Interface

The instrument can be connected to network via this interface to perform remote control.

3. USB Device

The oscilloscope support SCPI remote control commands, user can control the oscilloscope through this interface

4. Pass/Fail or Trigger Out

The BNC port can output a signal that reflects the current waveform capture rate of the oscilloscope at each trigger or a pass/fail test pulse.

5. Safety Lock Hole

You can lock the instrument to a fixed location using the security lock (please buy it yourself) via the lock hole.

6. AC Power Socket

AC power input terminal. The power requirements of this oscilloscope are 100-240 V, 50/60/400 Hz. Use the power cord provided with the instrument to connect it to AC power.

Front Panel Overview

Horizontal Control

Roll

Quickly enter into the Roll mode.

The timebase range is from 50 ms/div to 100 s/div.

Search

Enable or disable search function. This function can search for the events that users specify in the acquired data, the results are displayed with white triangle symbol.



4-channel scope



2-channel scope

Horizontal POSITION



Sets the horizontal location of the trigger event on the display. The waveform will move left or right when you turn the knob. Meanwhile, the Delay value will increase or decrease as the waveform moves. Press down the knob to reset the trigger delay to zero.



Horizontal Time Base

Set the timebase Turn it clockwise or anticlockwise to reduce or increase the timebase. The wave will be expanded or compressed when the timebase changes. Press down the knob to enter into the Zoom.

Trigger Control

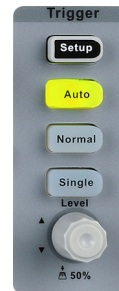

4-channel scope



2-channel scope

Setup

Press the button to open trigger menu. This oscilloscope provides various trigger types: Edge, Slope, Pulse, Video, Window, Interval, DropOut, Runt, Pattern and Serial Bus (IIC/SPI/UART/RS232/CAN/LIN)

We will introduce Video, Interval, Runt, Pattern and Serial Bus trigger in the following

HDTV Video Trigger

The oscilloscope supports analog video signal (NTSC/PAL) trigger and HDTV signal trigger. In video trigger, you can select custom to set any line and field

Interval Trigger

The time interval from the rising edge (or falling edge) of input signal passes through the trigger level to the next rising edge(or falling edge) passes through the trigger level and the currently set time satisfy the Limit Range ($< =$, $> =$, [----], --) [--] selected

In the figure below, the time interval between two continuous rising edge and the currently set time satisfy the limit range ([----])

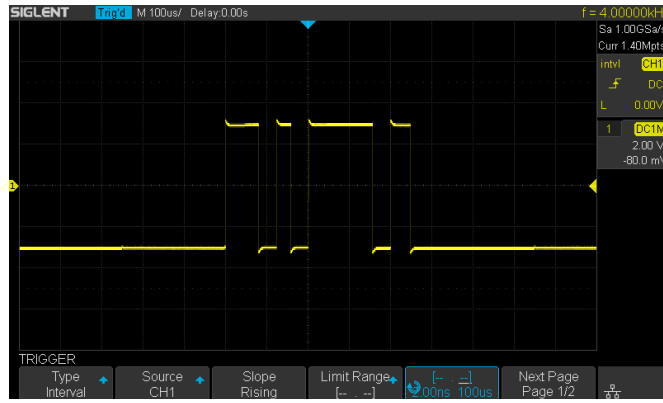

Runt Trigger

Runt trigger includes positive runt trigger and negative runt trigger. This mode is used to trigger pulses that pass through one trigger level but fails to pass through the other trigger level as shown in the figure below.

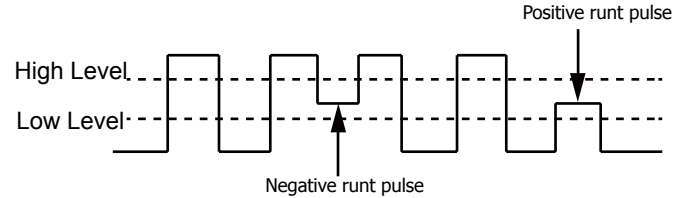

In the figure below, the trigger signal are positive runt pulse.

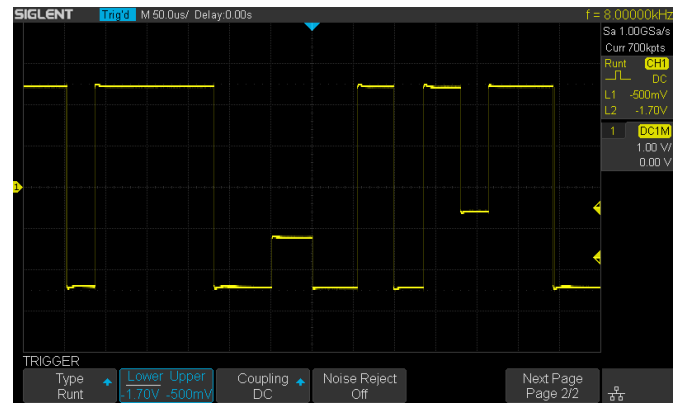

Pattern Trigger

Identify a trigger condition by looking for a specified pattern. This pattern is a logical combination (AND/OR/NAND/NOR) of the two channels. Each channel can be set a value among High, Low or Invalid.

In the figure below, the selected logic is "NAND", channel 1 is set to "Low", channel 2 is set to "High".



IIC Trigger

After setting the serial 1 or 2 to IIC type in trigger menu, you can use universal knob to set to trigger on start/stop condition, restart, no ack,EEPROM, or on the read/write frame with specific device address and data value. During IIC trigger settings, it is essential to set source channel previously in decode menu.

In the figure below, the trigger condition is set to "Start", channel 1 is set as Clock signal, channel 2 is set as Data signal

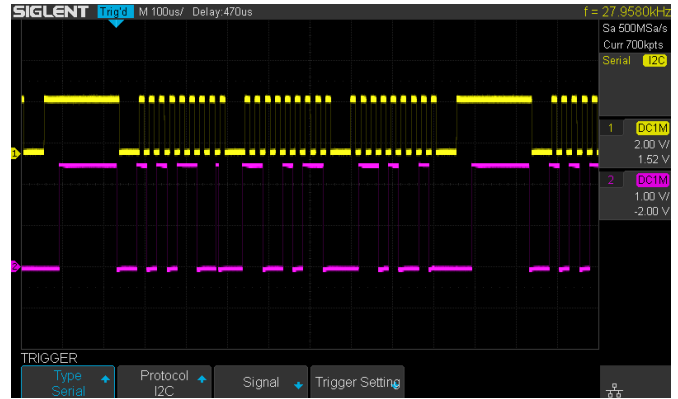

SPI Trigger

After setting the serial trigger to SPI type in trigger menu, you can select to trigger on MISO data or MOSI data. The data length are variable to set from 4 to 96.

UART/RS232 Trigger

After setting the serial trigger to UART/RS232 type in trigger menu, you can select to trigger on start , stop, checksum error or data. The data width are variable to set from 5 to 8bits.

CAN Trigger

After setting the serial trigger to CAN type in trigger menu, you can select to trigger on start, remote, ID, ID+DATA or Error of CAN-H or CAN-L signal.

LIN Trigger

After setting the serial trigger to LIN type in trigger menu, you can select to trigger on Start, ID, ID+DATA or Data Error.

[Notes: For more trigger types and corresponding operation information, please refer to the trigger chapter of SDS1000X-E & SDS1000X-U User Manual.](#)

Auto

Press the button to set to Auto trigger mode.

Normal

Press the button to set to Normal trigger mode.

Single

Press the button to set to Single trigger mode.



Level

Set the trigger level. Turn it clockwise or anticlockwise to make the level move up or down. In the meanwhile, the level value displayed at the upper right of the screen will increase or decrease. Press it down to quickly reset the trigger level to the 50% of waveforms.

Vertical Control



SDS1000X-E 4-channel scope

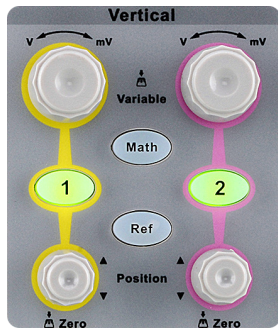

SDS1000X-E 2-channel scope



SDS1000X-U scope

1

Analog input channels. The four channels are marked by different colors which are also used to mark both the waveforms on the screen and the channel input connectors.

Press channel button to open the corresponding channel and press again to turn it off.

Math

Press the button to open math operation menu under which the operation of adding, subtracting, multiplying, dividing, FFT, integral, differential and square root are supported.

Ref

Press the button to enable the reference waveform function, thus to compare the current waveform with the reference waveform to decide circuit failures.

Digital

Press the button to open the digital channel function menu (Optional function). The SDS1000X-E (4-channel scope) supports 16 digital channels.



Vertical POSITION

Set the vertical offset of current waveform. Turn clockwise to increase the offset while turn anticlockwise to decrease the offset.

During the modification, the waveform will move up and down and the offset message at the lower part of the screen will change along. Press down the knob to quickly reset the offset to zero



Vertical Scale:

Set the vertical scale of current waveform.

Turn clockwise to decrease the scale and while turn anticlockwise to increase it. During the modification, the 'amplitude' of the waveform will enlarge or reduce and the scale message at the right side of the screen will also change. Press down the knob to quickly switch the vertical scale adjustment modes between "Coarse" and "Fine".

Run Control



Press the button to enable the waveform auto setup function. The oscilloscope will automatically adjust the horizontal time base, vertical scale and trigger mode according to the input signal to provide a triggered stable display.



Press the button to set the state of the instrument to "RUN" or "STOP". In the "RUN" state, the button glows yellow; In "STOP" state, the button glows red.

Universal Knob



Adjust Waveform Intensity/ Graticule/ Transparence

You can press **Display Persist** → Intensity and use the knob to adjust waveform intensity (0% ~ 100%). To adjust graticule (0% ~ 100%) or transparency(20% ~ 80%) ,please operate in the same way as waveform intensity.

Universal Knob

In menu operation, when the light below the knob is lit, you could turn the knob to select between submenus under the current menu and press it down to select the current submenu. In addition, it can also be used to modify parameters and input the filename.

Function Menus

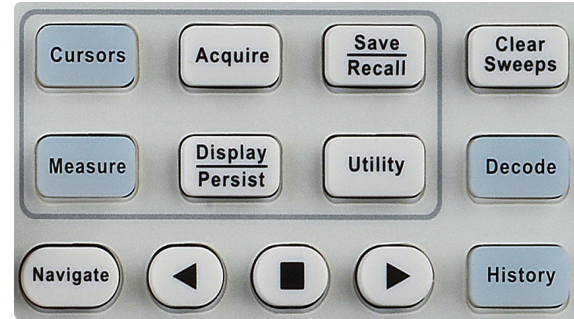

4-channel scope

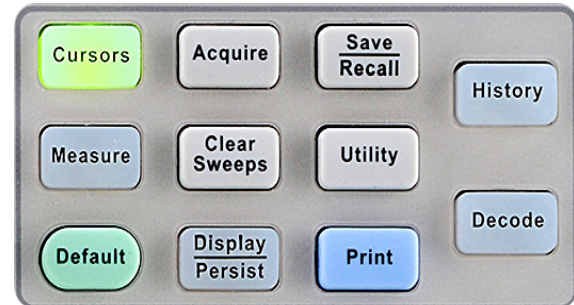

2-channel scope

Cursors

Press the button to open the cursor function. It provides manual and track cursor mode.

Display
Persist

Press the button to enter the display menu and quickly enabled the persist function. User can set the grid, intensity, graticule, transparency.

Utility

Press the button to enter the utility menu to set system functions or parameters, such as IO set, sound, language. In addition, some advanced functions (such as Pass/Fail, Do Self Cal, install option function and Update) are also supported.

History

Press the button to enter the history mode. In history mode, it can record most 80000 frame waves

Measure

Press the button to enter the measurement setting menu. You could set measurement type, statistic function, all measure and gate measure. You can select as many as four parameters. In statistic function, the Current value, Mean, Min, Max, Std-Dev and Count are shown on the screen. In all measure, you could show all the parameters of the channel you select

Acquire

Press the button to enter the sample menu. You can set the acquisition mode (Normal/Peak-Detect/Average/Eres), interpolation mode (Sinx/X or linear) and memory depth. You could enable the XY function and sequence function.

Save
Recall

Press the button to enter the file save and recall function menu. The storable file types includes Setups, Waveforms, Picture and CSV.

Default

Press the button to reset the oscilloscope to its default setup. In the file save and recall function menu, user can customize the default setup.

Decode

Press it to open decode menu. Decode is a optional function. Supports two serial buses including 1 and 2 for analog signal decoding. The protocols include IIC, SPI, UART/RS232, CAN and LIN.

Navigate

Press the button to turn off or turn on the navigate function. 4-channel scope supports three navigate types: time, search event, history frame.

User Interface

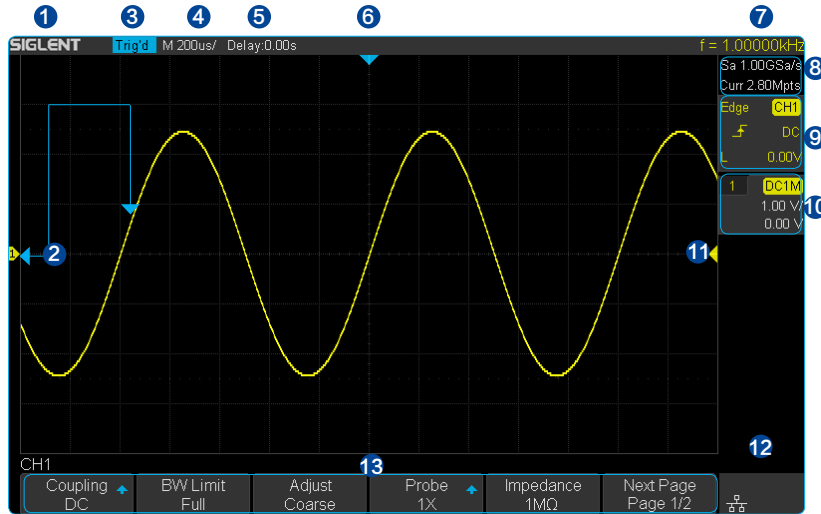

1. Product Logo

SIGLENT is the registered trademark of our company.

2. Channel Label/Waveform

Different channels are marked by different colors and the color of the waveform complies with the color of the channel.

3. Working state

Available states include Arm, Ready, Trig'd, Stop, Auto.

4. Horizontal Time Base

Represent the time of each grid on the horizontal axis of the screen. You could revolve  to modify the parameter which is variable from 2ns ~ 100s.

5. Trigger Position

Use horizontal **POSITION**  knob to modify the parameter. Turn clockwise or counterclockwise to make the waveform move right or left, which will respectively cause the Delay parameter to decrease or increase. Press down the knob to automatically reset the parameter to zero as well as make the waveform return to horizontal center of the screen.

6. Trigger Position

Display the trigger position of the waveform on the screen.

7. Frequency Counter

Display the firmware frequency of current waveform.

8. Sample Rate/Memory Depth



Display the current sample rate and memory depth of the oscilloscope. Use horizontal SCALE knob to modify the parameter.

9. Trigger Setting

Trigger Source  Display the trigger source currently selected. Different labels are displayed when different trigger source are selected and the color of the trigger parameter area will change accordingly.

Coupling Mode  Display coupling mode(DC/AC/ LF Reject/HF Reject) of the current trigger source



Trigger Level  Display the trigger level value of the current waveform. Press down the knob to reset the parameter to 50% of the waveform.

Trigger Type  Display the currently selected trigger type and trigger condition setting. Different labels are displayed when different trigger types are selected. For example:  means triggered on Slope side in edge trigger.

10. Channel Setting

Channel Coupling  Display the selected coupling mode of the current channel. All modes are: DC/AC/GND.

Voltage Scale  Represent the voltage value of each grid on the vertical axis of the screen.

BW Limit  If the current "BW Limit" is "On", then the mark  is displayed.

Impedance  Display currently selected impedance (1M Ω) of the channel.

11. Trigger Level Position

Display position of the current channel trigger level. Pressdown the knob to reset the level to vertical center of the waveform.

12. I/O Connection Status

 Indicates the USB Host is connected.

 Indicate that the WLAN is connected.  Indicate that the WLAN is disconnected.

 Indicates the Lan is connected.  Indicates the Lan is not connected.

13. Menu

Display menus of the currently selected function module. Press any menu softkey to perform corresponding setting

Using Security Lock

If needed, you could use the security lock (please buy it yourself) to lock the instrument in a fixed location. The method: align the clock with the clock hole and plug it into the lock hole vertically, turn the key clockwise to lock the instrument and then pull the key out.

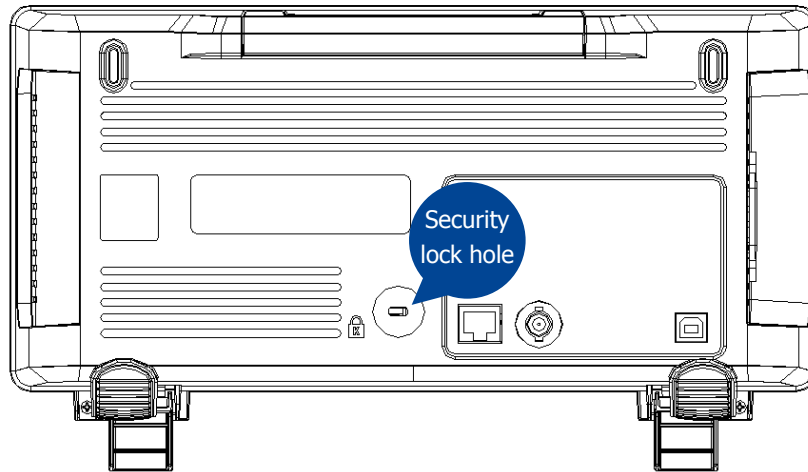

Trouble Shooting

The general failures and consequential solutions are listed below. When you find them, please deal with them in the following corresponding ways. If the problem proves to be unsolvable, please contact SIGLENT as soon as possible.

1. The screen remains dark after power on:

- (1) Check if the power is correctly connected.
- (2) Check if the power switch is faulted.
- (3) Check whether the fuse is burned out. If the fuse needs to be changed, please contact SIGLENT as soon as possible and return the instrument to the factory to have it repaired by service personnel authorized by SIGLENT.
- (4) Restart the instrument after completing inspections above
- (5) If it still does not work normally, please contact SIGLENT.

2. After the signal is sampled, there is no corresponding waveform displaying:

- (1) Check if the probe is correctly connected to the signal connecting cord.
- (2) Check if the signal connecting cord is correctly connected to BNC.
- (3) Check if the probe is correctly connected to the item under test.
- (4) Check if there are signal generated from the item under test.
- (5) Resample the signal.

3.The voltage amplitude measured is higher or lower than the actual value (the error usually occurs in use of the probe): Check if the attenuation coefficient of the current channel matches with the attenuation ratio of the probe.

4. There is waveform displaying but not stable:

- (1) Check the trigger source: check whether the "Source" in menu of "TRIG" is the actual operating channel.
- (2) Check if the waveform is wrong: it is easy for us to regard the wrong waveform as the real when a high frequency signal is connected to the instrument. You'd better make sure that the current time base is correct.
- (3) Check the trigger type: "Edge" trigger suits to general signal and "Video" trigger suits to video signal. Only in correct trigger type can the waveform stably displays.
- (4) Change the setting of trigger holdoff.

Trouble Shooting

5. No display after pressing :

Check whether the trigger Mode is "Normal" or "Single", and if the trigger level exceeds the waveform range. If yes, set the trigger level to the middle or change the trigger Mode to "Auto".

Note: press "Auto Scale" could automatically replace the above setting.

6.The waveform displays like ladder:

- (1) The horizontal time base may be too low, you can increase it to improve the horizontal resolution so as to make a good waveform displaying.
- (2) The lines between the sample points may also cause ladder-like displaying if the "Type" in menu of "DISPLAY" is "Vectors". Please turn the "Type" to "Dots" to solve the problem.

7.USB storage can't be recognized:

- (1) Check if the USB flash disk can work normally.
- (2) Check if the USB Device Host can work normally.
- (3) Make sure the USB disk being used is of flash type, the instrument does not support USB of hardware type.
- (4) Restart the instrument and then insert the USB to check it.
- (5) If it is still in abnormal use, please contact with SIGLENT.

Contact SIGLENT

America

SIGLENT Technologies America, Inc

6557 Cochran Rd Solon, Ohio 44139

Tel: 440-398-5800

Toll Free: 877-515-5551

Fax: 440-399-1211

info@siglent.com

www.siglentamerica.com

Headquarters

SIGLENT TECHNOLOGIES CO., LTD.

Blog No.4 & No.5, Antongda Industrial Zone, 3rd Liuxian Road, Bao'an District, Shenzhen, 518101, China.

Tel: + 86 755 3661 5186

Fax: + 86 755 3359 1582

sales@siglent.com

www.siglent.com/ens

Europe

SIGLENT Technologies Germany GmbH

Add: Staetzlinger Str. 70

86165 Augsburg, Germany

Tel: +49(0)-821-666 0 111 0

Fax: +49(0)-821-666 0 111 22

info-eu@siglent.com

www.siglenteu.com

